

UNCLASSIFIED

AD 887528

Armed Services Technical Information Agency

Reproduced by

DOCUMENT SERVICE CENTER

KNOTT BUILDING, DAYTON, 2, OHIO

This document is the property of the United States Government. It is furnished for the duration of the contract and shall be returned when no longer required, or upon recall by ASTIA to the following address: Armed Services Technical Information Agency, Document Service Center, Knott Building, Dayton 2, Ohio.

NOTICE: WHEN GOVERNMENT OR OTHER DRAWINGS, SPECIFICATIONS OR OTHER DATA ARE USED FOR ANY PURPOSE OTHER THAN IN CONNECTION WITH A DEFINITELY RELATED GOVERNMENT PROCUREMENT OPERATION, THE U. S. GOVERNMENT THEREBY INCURS NO RESPONSIBILITY, NOR ANY OBLIGATION WHATSOEVER; AND THE FACT THAT THE GOVERNMENT MAY HAVE FORMULATED, FURNISHED, OR IN ANY WAY SUPPLIED THE SAID DRAWINGS, SPECIFICATIONS, OR OTHER DATA IS NOT TO BE REGARDED BY IMPLICATION OR OTHERWISE AS IN ANY MANNER LICENSING THE HOLDER OR ANY OTHER PERSON OR CORPORATION, OR CONVEYING ANY RIGHTS OR PERMISSION TO MANUFACTURE, USE OR SELL ANY PATENTED INVENTION THAT MAY IN ANY WAY BE RELATED THERETO.

UNCLASSIFIED

AF 61 (514)-898-56-19

RESEARCH AND DEVELOPMENT COMMAND NO: AD 87528

FC

87528

EFFECTS ON LIVING TISSUES
BY PRIMARY COSMIC RAY PARTICLES

The research reported in this document has been sponsored in part by the AIR RESEARCH AND DEVELOPMENT COMMAND, UNITED STATES AIR FORCE under Contract AF 61 (514)-898, through the European Office, ARDC

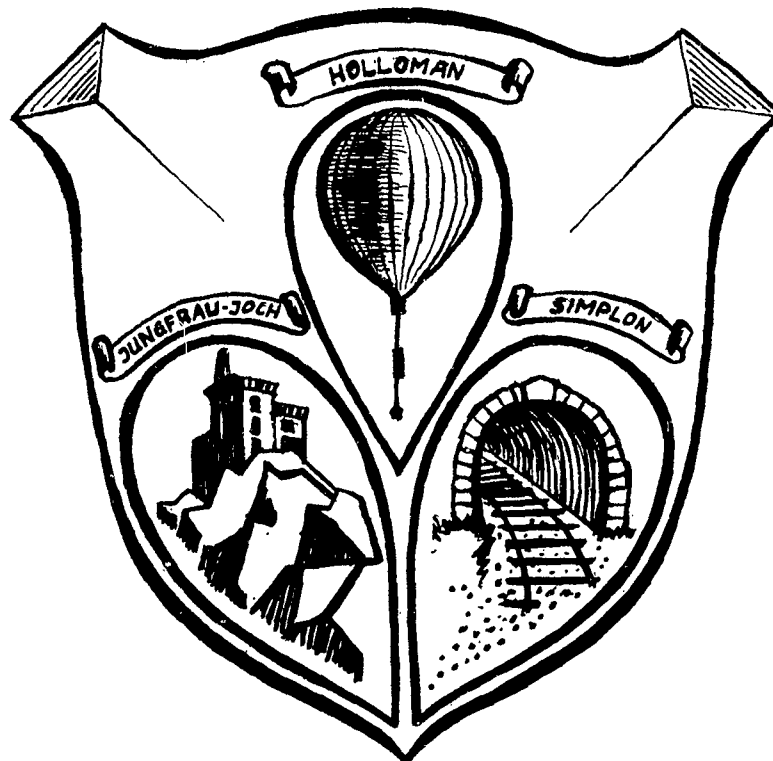

reported by

Jakob A. G. Eugster (MD)
Prof. of Geographical Medicine
University of Zurich (Switzerland)

FEBRUARY 1956

EFFECTS ON LIVING TISSUES
BY PRIMARY COSMIC RAY PARTICLES

The research reported in this document has been sponsored in part by the AIR RESEARCH AND DEVELOPMENT COMMAND, UNITED STATES AIR FORCE under Contract AF 61 (514)-898, through the European Office, ARDC

by

Dr. Jakob A. G. Eugster, Professor of Geographical
Medicine, University of Zurich, Switzerland

Dr. Hermann Waeffler, Professor of Physics,
University of Zurich, Switzerland

Dr. Werner Roost, Oberarzt, Chirurg. Universitäts-
klinik Bern

Work in collaboration by David G. Simons,
Major USAF (MC) Chief, Space Biology Branch Aero
Medical Field Laboratory
Holloman Air Force Base

FEBRUARY 1956

TABLE OF CONTENTS

	Page
Abstract	2
I. Preface	4
II. Factual Data	6
III. Discussion	17
IV. Recommendations	18
V. References	19
VI. List of Previous Publications	21

LIST OF ILLUSTRATIONS

Figure		Page
1	Correlation tracks and dye effects	23
2	Cosmic Ray Star in human tissue	24
3)	
4) Technique of Investigations	25
5)	
6)	
7) Histology	26
8)	
9)	
10) Exposure of human skin samples	27
11)	
12)	

ABSTRACT

This report presents the results of experiments to determine the effect of cosmic rays (CoR) on the tissues of living humans and animals. Tests have been conducted

- 1) in Switzerland
 - a) at 11, 000 feet (the Jungfrauoch)
 - b) in Payerne (stratosphere balloon flights)
 - c) in the Simplon tunnel (8000 feet below the mountain top) as a permanent control station.
- 2) Specimens are prepared and shipped to the Holloman Air Development Center for lights in "sky hooks" and similar high altitude balloons 90-100, 000 feet (with special assistance by Major D. Simons, chief, Space Biology Branch).

The total number of experiments made is 55 of which 18 on human tissue. Of the latter, only 3 gave conclusive positive results, which is due to the fact that none of the tests could be carried out at geo-magnetic latitudes of more than 55° N. Consequently there will be little or no exposure to heavy primaries with pre-thin down hits which have an enormous density of ionization.

In this report, we have confined ourselves to 2 points of view:

- a) to the results of experiments on living human and animal tissue;
- b) to observations over a long period with exposed preparations after the period of exposure.

To the decisive question whether in the case of human beings serious danger to health is to be expected during a stay of about 2 days at these heights, we make bold to reply as follows:

Both the extreme view that we can make light of this possibility and the other extreme view that flights at heights of over 100, 000 feet are not possible owing to the harmful effects on human beings of cosmic rays can now be dismissed out of hand.

In spite of the paucity of evidence up to the present time, the following conclusion is admissible:

The truth lies midway between these two extreme views. Harmful effects occur extremely rarely, as the harmful component itself is seldom present and the likelihood of its coming into contact with vital tissue (for instance certain cells of the brain or of the organs of sense) is very very slight.

As compared with the meagre positive results achieved at great heights, the observations carried out in the Simplon tunnel have met with surprising success in quite a new direction, inasmuch as here the biological objects did not react as expected, but their activity was reduced all along the line. At this control station, the radiation of the whole environment with and without the screening off of rock radiation was subjected to constant physical control for 6 years. Here the cosmic rays were eliminated as was also the rock radiation by means of a 10 cm iron box. The interior of this box was ventilated with radon-free air. Temperature and moisture were adapted to the conditions obtaining on the surface of the earth (laboratory tests).

I. PREFACE

PURPOSE

The Contractor performed experiments to determine the effects of cosmic rays on the living tissues of humans and animals. The experiments were carried out

1. in Switzerland
 - a) at the Jungfrauoch (alt. 11'000 feet, geomagnetic latitude 49°)
 - b) in the Simplon Tunnel (8'000 feet below the mountain top, geomagnetic latitude 46°40')
 - c) Payerne, "station aerologique", geomagnetic latitude 50°.
2. Specimens were prepared and shipped to the Holloman Air Development Center flights in "sky hook" and similar high altitude balloons (with special assistance from Major David G. Simons, Chief, Space Medicine Laboratory).

After exposure at high altitudes the specimens were returned to Switzerland for studies.

METHOD

The observations made in the experiments on the effects of heavy primaries on human and animal tissues were followed up in the living organism by means of long-term observation of an experimental material as large as possible.

The method involves close cooperation with the surgeon, who reimplants in the parent organism the pieces of tissue previously removed under sterile conditions, e.g. omentum, skin and precancerous mouse tissues (so-called auto-reimplantation). The transport was effectuated in two different ways:

1) Those specimens which had been exposed at app. 70-75'000 feet at the Swiss Central Meteorological Station in Payerne by means of balloons were returned to us within, on the average, 48 hours. Here the so-called serum method was used, i. e. the living specimens are stored in containers well tightened, with homologous serum as bathing fluid. A special "micro-frigidaire" system maintains a temperature of +2, +3° C.

2) The specimens sent to Holloman were transported under vacuum. The tissue was dehydrated, then refrigerated suddenly at -72° C. After reimplantation the marking out of hits by means of vital dye (Triphenyl - tetrazolium - chloride = TTC) and Ilford G5 emulsion made it possible to follow up the effect in the living tissue over a long period of observation. A special technique permits microscopic examination of living cell systems (the light being made to fall vertically through the tubus of the microscope by means of a built-in prism).

In analogy with x-ray effects, a longer period of latency must be allowed for with cosmic radiation. Thus this long-term observation in the living organism is an obvious experimental condition.

II. FACTUAL DATA (Protocols)

PART A. PRELIMINARY EXPERIMENTS

Series I

- Material: Eggs of *Artemia salina*.
Number of eggs exposed: 240'000.
- Place:
- a) Zoological Institute Zurich.
(Ground level controls).
 - b) Laboratory in the Simplon Tunnel,
8'000 feet below the mountain top.
(Absolute controls).
 - c) International Research Institute,
Jungfrauoch, alt. 11'000 feet.
 - d) high altitude balloons.
 1. Payerne, Switzerland. Geo-
magnetic latitude 50°, altitude
attained: 75'000 feet.
 2. Holloman, New Mexico. Altit-
ude attained: 90'000 feet.
- Method: "Raster-Platten", i. e. a plexi-glass
plate perforated by a regular system of
circular holes. Above and below are
mounted Ilford G5 plates for monitoring
the hits of CF. Fig. 3.
- Results: The eggs having suffered central hits
by a heavy primary showed a hatching
rate of 2 % as compared to controls.
The existence of dominant letal factors
has been proved. (Vide: List of previous
publications: Bulletin Schweiz. Ges.
f. Anthropologie 1952/53, p. 49.

Series II

Number of experiments: 4

Material: Skin of pig.
(Protocol No. II, 9, p. 56, 10, 11 & 12).

Place: Jungfrauoch.

Method: Injection of Ilford G5 emulsion into excised pieces of living tissue.

Time of exposure: 36 days.

Experimental purpose: Demonstration of tracks in tissue and comparison of their frequency with the tracks on the photographic plates.

Results: Demonstration of numerous CR tracks and fission figures. (Results published in: Experientia, Vol. 7, fasc. 12, December, 1951).

Series III

Number of experiments: 2

Polonium irradiation of pieces of human skin imbibed with TTC.
Dose: 1.06 mC/0.25 cm² (measured at the Institute of Radiochemistry, Berne).

Purpose: Detection of alpha rays in tissue by means of the vital dyw technique.

Method: A piece of skin, 4 by 2 cm, is excised under aseptic precautions and freed of blood by thorough rinsing. After impregnation with a 5 % aqueous solution of TTC it is then irradiated with polonium (comp. fig. A).

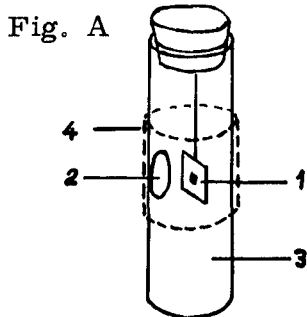

1. polonium sample fixed to a thin metal blade, which is fixed to the stopper.
2. window in metal mantle.
3. metal mantle.
4. piece of skin wrapped around mantle and covering window.

Time of exposure: 68 hours in refrigerator at +2° C.

Results: Skin area covering window stained distinctly red, model experiment thus giving a definitely positive result.

PART B. EXPERIMENTS WITH ANIMAL TISSUES

Series IV

Number of experiments: 4
Protocol No. IV, 154, 154a, p. 46, 58.

- Material: excised, precancerous pieces of dog skin.
a) Doberman, 2-year-old, female.
b) Dachshund, Swiss.
- Place: Payerne, balloons attaining 75'000 feet.
- Method: Fluid container with gauze impregnated with mineral oil. Specimen mounted on cork support.
- Time of exposure: 4 to 5 hours.
- Results:
a) basal cells of skin showing tracks. Basal-celled carcinoma arising from the pigmented cells of the stratum germinativum of the surface epithelium and from the hair matrices.
b) development of granulation tissue at the loci corresponding to hits (piece of skin from right auricle).

Series V

Number of experiments: 10

- Material: 10 mice obtained from the Histopathological Institute, University of Zurich.
- Method: "Dry technique". A piece of skin (3 cm²) from the dorsum is excised under aseptic precautions in Numal (Roche) anesthesia (dose 2.5 mg) and thoroughly dehydrated by means of ethylene glycol. It is then placed in a pyrex glass tube and cooled to -78° C. The tube is immediately evacuated to 0.05 mm of mercury, its open ends are sealed by heating and finally it is wrapped in 6 Ilford films (without support).

Place and time
of exposure:

Holloman Air Force Base, New Mexico; 30 hours at levels above 85'000 feet. Flight No. 39

Results:

In spite of a (storage) period of 2 months under the above conditions the specimens remained viable after immersion in physiological saline. The auto-reimplantation was successful in 6 of the 10 mice. The cork slice supports contained only 2 hits definitely due to heavy primaries, whose penetration was controllable from the exterior by means of the Ilford films. A biological effect could be demonstrated in one case only (granuloma).

Series VI:

Number of experiments: 6
Protocol No. 73-84.

Material:

horse blood.

Method:

Twelve Ilford B₂ plates were half covered with dried blotting paper which had been soaked in horse blood.

Purpose:

evaluation of the number of nuclear fission figures to be observed with and without a cover of blood.

Place:

Jungfrauoch, alt. 11'000 feet.

Time of exposure:

Two months.

Results:

Individual counting of plates No. 73-84 showed a greater number of nuclear fission figures (by 15-20 %) in those halves covered with blood compared to the halves left uncovered.

Series VII

Number of experiments: 24
Protocol No. I II/16, I II/22, I II/28, No. X 135.

Material: Fibroblast cultures.

Method: In automatically regulated rotating apparatus provides for the movement of the culture flasks.

Place: a) Laboratory in the Simplon Tunnel (8'000 feet below the mountain top). Temp. 37°.
b) Jungfrauoch, incubator at 37°.
c) Controls: Laboratory at the Centre Anticancereux Romand, Lausanne. Temp. 37°.

Time of exposure: Two weeks.

Results: Impairment of growth in the Simplon Tunnel.

PART C. EXPERIMENTS WITH HUMAN TISSUES

Series VIII

Number of experiments: 2
Protocol No. VII, VIII, VII, I 53.

Material: Excised pieces of human skin. Pathological Institute Berne.

Method: Injection of skin with Ilford G5 emulsion and mounting on cork support. The specimens are packed on ice and placed in an insulating container (Schildknecht's system).

Place: Payerne. Special balloons attaining 75'000 feet.

Time of exposure: 5 hours.

Results: Demonstration of distinct CR tracks with nuclear fission figures with a diameter exceeding 450 microns.

Series IX & X

Number of experiments: 2

Protocol No. J₉, 10

Material: Piece of skin, thickness 2-3 mm.
Removed under aseptic precautions during plastic surgery necessitated by an accident (case R. F., young, healthy adult male).

Method: Model experiment. Piece of skin injected with a 5 % aqueous solution of TTC. Artificial irradiation through window by means of UO₃, distance 3 mm, dose 25mr/h.

Time of exposure: 18 hours at 30° C.

Results: The irradiated part of the specimen showed a diffuse orange-red straining.

Series XIII - XVI

Number of experiments: 4

Material: Piece of human omentum majus.

Method: Specimen injected with Ilford G5 emulsion and mounted on cork slice.

Place: Jungfrauoch (alt. 11'000 feet).

Time of exposure: Two months.

Results: Tracks of CR with abnormally large nuclear fission figures with a diameter up to 500 microns. (Publication: Radiologia Clinica, Vol 22, No. 2, 1952). (See Fig. 2, page 24)

Series XX & XXI

Protocol No. I XX & XXI.

Material: Pieces of skin removed aseptically with a dermatome during plastic surgery following amputation of the breast (Case E. R.).

Method:

"Wet technique".

Specimen stored in plasma after preliminary treatment with TTC dye. A special refrigerating aggregate, manufactured by the firm CARBA, was used. Temperature control by means of a special metallic thermometer (Temperature maxima and minima).

Re-implantation 6 days after excision. The bacteriological examination of the stored specimen revealed it to be sterile. At a control examination 2 weeks later the implant had "taken" and was dry.

Place:

Payerne, Balloon 70-71'000 feet, 6 hours.

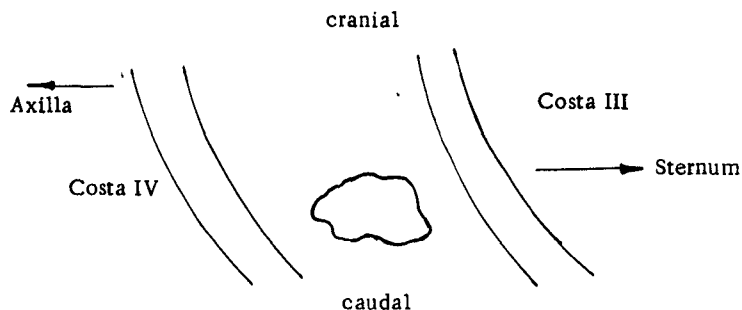

Results:

At 2 points marked out by the TTC (i. e. hits) small granulomas developed after 2 months.

Series XXIII & XXIV

Number of experiments: 2

Protocol Cyl., B & C.

Case A. E. G., healthy male.

Material:

Piece of skin (4 cm²) removed aseptically with a dermatome from left upper arm and right side of thorax, medial to the right mamilla.

Method:

The specimens were stored in plasma after preliminary treatment with TTC dye. A special refrigerating apparatus, type CARBA, was used, as well as an insulating container coated with paraffin. The outside of the container was provided with a black - white striation in order to assure equilibration of temperature. An auto-reimplantation was done after 4 weeks.

Place:

Payerne, special balloon attaining 70'000 feet. Ascent in calm and very cold weather (December). The cylinder marked "B" was lost.

Results:

Macroscopically the specimen looked fresh, the nutritive medium was odourless. In the middle of the specimen 4 small red points were found, hardly visible to the naked eye. The hits so marked out were tangential, emanating from one point (vide accompanying figure).

1) side view



plexiglass tube serving as mounting for the specimen

2) view from above:

Mamilla

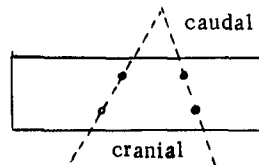

Sternum

3 cm

Now the crucial question is this: What is to be seen at the loci of the hits in normal human skin?

At first absolutely nothing!

Fig. 8-12 show a reimplanted specimen a short time after the exposure. Two red points are visible, originating from a hit

which probably penetrated specimen and mounting (cork slice) in an oblique direction.

Control examination 2 weeks later: No changes are visible at the loci of the hits.

Three weeks after reimplantation: Fig. 12 depicts the situation at this time. The small circle with two coordinates, which was tattooed into the specimen immediately upon tis return, contains at its center exactly those hits previously marked out by the vital dye. The latter by this time has undergone resorption, which proves that it was in intimate contact with the tissue. Control experiments with vital dye without irradiation showed it to be absolutely innocuous to living cells. Also, this can be deduced from the use of TTC in aqueous solution for the demonstration of the ability of seeds to germinate.

This use of TTC for the detection of radiation effects rests upon the fundamental work of A. T. Krebs und Z. S. Gierlach (References No. 6).

After 4 weeks: No macroscopically detectable changes are present.

After 5 weeks: The beginning formation of a small granuloma with a diameter of 2 mm can be observed at the loci of the hits. Evidently a marked period of latency is involved.

Observation over one year: The microscopical examination was purposely omitted in order not to influence the macroscopical picture as long as possible. Any biopsy might disturb the evolution of the process. After about 12 months a light brown pigmentation shows up in the two small tumours. Every month the pigmentation became a darker color of brown. This observation parallels to a certain degree the findings of Herm. B. Chase, according to which hits in the matrices of mouse hairs also caused pigmentation anomalies to appear.

Series XXV

Number of experiments: 6.

<u>Material:</u>	Pieces of human skin removed aseptically.
<u>Method:</u>	"Dry" technique. In contradistinction to the "wet" technique described under Series XX the following procedure is used:

After aseptic removal the specimens are immediately thoroughly dehydrated in ethylene glycol (glycerin can be used for the same purpose) and are then dried. They are mounted on a support consisting of a sterile cork slice by means of a sterilised adhesive substance used surgically and are placed in a pyrex glass tube. Since under these circumstances one is working with dehydrated material, the TTC solution cannot be applied to the specimen, as is the case with the "wet" technique, where the specimen is continuously immersed in serum. Instead, the TTC solution is incorporated in the gelatine mixture previously described (Fig. 1) and applied directly to the cork support.

Without loss of time the specimen is now subjected to the conservation process described by Rob. B. Brown (Ref. No. 2): It is rapidly deep-frozen to -78°C , the pyrex glass tube is evacuated to 0.05 mm of mercury and desiccated. It is then sealed by heating its ends and stored for 72 hours at -35°C .

When stored under vacuum the specimen will remain at room temperature in a transplantable condition for several months, and so it is quite feasible to send it out of the country for exposure. Preliminary to the auto-reimplantation the specimen is reactivated in physiological saline.

The advantage in this technique lies in the possibility of a long-term storage; the disadvantage consists of the reduced sensitivity of the specimens which is determined by their dry state. On the other hand, the "wet" technique allows only the relatively short storage period of a few days, however, the specimen remains much more radiosensitive in its wet state.

Fig. 4 depicts a piece of skin mounted on a cork support and stored in an evacuated pyrex glass tube. The red point marks out the locus of a heavy primary hit in the dye - gelatine substratum after its penetration of the thin piece of skin. The glass tubes were covered on two sides with 6 Ilford G5 plates each (thickness 400 microns), so that the vital dye registration of the heavy primaries could be further controlled.

Place: Holloman Air Force Base, New Mexico. (Aero Medical Field Laboratory, Holloman Air Development Center). The transportation of this series was accomplished with the cooperation of the U. S. Embassy in Berne.

Time of exposure:

Flights No. 46 and 47, together total 65 hours between 90 and 95'000 feet.

Results:

The specimens were returned in excellent condition. After immersion in physiological saline the pieces of skin swelled and looked fully viable.

The histological examination furnished proof of the viable state of the nuclei in the lower epidermal strata, two months after the excision.

Vital staining with neutral red in saline and counterstaining with methylene blue yielded a normal picture of the cell nuclei.

In the 6 specimens exposed only a single big hit could be found. The locus in question is still under observation today, thus far without any special abnormality having appeared. (The result being, up to now, definitely negative).

III. DISCUSSION

1. OBSERVATIONS AT THE CONTROL STATION IN THE SIMPLON TUNNEL

From the observations carried out for many years with a large quantity of material, we may certainly conclude that biological objects (in particular seeds and eggs of *arthemia salinae*) in an environment in which the hard environment radiation (including cosmic rays) has been eliminated, develop less well than on the surface of the earth. In other words, every biological occurrence tends in the course of time to adapt itself to the radiation of the environment. Thus cosmic rays in small quantities such as are found on the surface of the earth act as "stimulants" and actually have a "beneficent effect on biological development.

2. DISCUSSION OF THE EFFECTS AT GREAT HEIGHTS

Hits by heavy atomic particles with high and very high numbers (49) very seldom occur. Most of the preparations did not show any such hits, though some of them showed more than had been expected, so that it may be conjectured that a sort of shower of heavy primaries is possible. Not all primaries have a biological effect. In the case of the human body, the transitional effect must be taken into consideration.

The bodies of small animals are not large enough for this.

The development of our experimentation technique is mainly devoted to the study of microscopic effects on the cellular system. By this method of observation, centres of stars of nuclear disintegration (explosion stars) can, in our opinion, also be effective. .

By means of observations of the points of impact on preparations, carried out over a long period, that is to say after allowing for a long period of latency (eight months or even more than a year), positive effects were observed in 2 cases. We must thus, in the case of certain occurrences, expect very long periods of latency, which makes the method still more complicated.

One in a case there are 3 phases to be observed: After a long latency of several months the first phase shows a injury of

the tissue; secondly it changed in a granuloma which finally was transformed in a veritable naevus pigmentosus. (Really: Cosmic Rays become a "Cosmetique" Radiation!)

Experience up to the present has gone to show how extraordinarily difficult the development of a reliable standard method has become.

No field of investigation has met with so many difficulties and obstacles as has that of experiments on animals at very great heights. A very small part of these experiments, repeated over a large number of years, have been rewarded by meagre positive results. For all that, I summarize, Cosmic Radiation will not be a great hazard for human body, hindering to fly in the Upper-Atmosphere.

I have therefore come to the conclusion that a good dose of luck and a very great deal of patience will be required before these investigations can lead us to our goal. (Patience and patience!)

IV. RECOMMENDATIONS

That method must be regarded as the best and most hopeful which will enable us exactly to locate the point of the hit.

This is at the present time achieved by means of nuclear films (without support) firmly attached in an appropriate manner to the skin of the animal (and especially to the head for examination of the brain) with sewn-in metal bands to keep them in place. At the same time, in order to prevent damage by heat and mechanical damage to the emulsion, a layer of gelatine is used as a protection. As a further method of detection for deeper layers of tissue, the dyestuff method should be further developed with a view to producing a greater degree of sensibility to ionization.

Lastly, with regard to the continuation of the experiments, I would like to recommend that for the most part flights be carried out at latitudes of more than 55° N, in order to render possible the observation of the thin-down effects, the animals being screened off in such a way as to ensure that the end of the track of heavy primaries falls in the body of the animals.

With a view to developing further the detection of heavy primaries in living tissues we urgently recommend experiments with silver azide, possibly silver nitride applied to the surface of specimens.

(cf. literature ref. No. 20 a).

V. REFERENCES

BIBLIOGRAPHY

1. H. Armstrong, H. Haber and H. Strughold
Aero Medical problems of space travel
J. Aviation Medicine 20: 383, Dec, 1949
2. Rob. B. Brown
Surgery, Gynec. and Obstetric. 1953 Vol. 97/657
3. Herman B. Chase, Janet D. M. Bliss, William E,
Straile Janice S. Post.
Effects on the skin by Co Ray Heavy Particles
Brown University Providence 12 R. J.
Holloman Air Force Base NM. May 1955.
HADC-TR-55-2
4. Herman B. Chase
Cutaneous Effects of Primary Cosmic
Radiation
Journal of Aviation Med. Vol. 25 Aug. 1954
5. E.P. George, M. George, J. Booth, E.S. Horning
Influence of Cosmic Radiation on Induced
Carcinogenesis in Mice.
Nature 164, 1949, p. 1044.
6. Z.S. Gierlach and A. T. Krebs
J. of Roentgenology and Ra Therapy
Vol. LXII No. 4, 1949
7. H. Haber
Scientific American Jan. 1951.
8. V.F. Hess and J. Eugster
Cosmic Radiation and its biological Effects,
Fordham Univ. Press N. Y. 1949
9. G. Joyet
Recherche expérimentale d'une action des
gerbes de rayons cosmiques dans la cancéri-
sation
Schwe. Med. W.schr. No. 37, 1945, S. 812.
10. A. T. Krebs
Journal of Aviation Med. 21: 481, 1950

11. P.A. Morris and W.J. Nickerson
Cosmic radiation and cancer mortality.
Experientia 4th July 1948.
12. J.J. Muller in Physics and Medicine of the Upper
Atmosph. edited by C. S. White, p. 611, 1952
13. David, G. Simons and C.H. Steinmetz
Physiological and radiobiological aspects of
the 1954 Aeromedical Field Laboratory balloon
flights
J. Aviation Med. 1955.
14. David, G. Simons Major USAF (MC)
Methods and Results of one Year of Balloon
Flights with Biological Specimens
Journal of Aviation Medicine, Vol. 25 Aug. 1954
15. David, G. Simons
Stratosphere Balloon Techniques for Exposing
living Specimens to Primary Cosmic Ray
Particles HADC TR 54-16, Nov. 1954
16. Herm. J. Schaefer
Journal of Aviation Med. 21: 375, 1950
25: 351, 1951
in Physics and Med. in the Upper Atmosphere
edited by C.S. White p. 611, 1952
17. Herm. J. Schaefer
Exposure hazards from cosmic radiation
beyond the stratosphere and in free space.
J. Aviation Med. 23: 334-355. 1952
18. E. Schopper
Cosmic radiation and its radiobiological
effectiveness
Roentgenblätter Vol. 4: No. 5, 1951
19. John B. Storer USAF (MC) et al.
Specific Ionization and Relative Biological
Effectiveness of Ionizing Radiations in
Mammalian Systems
J. of Aviation Med. Vol. 25, Aug. 1954
20. C.A. Tobias
Radiation hazards in high altitude aviation
J. Aviation Med. 23, 1952
- 20 a. J. Egger t
Physikal. Blätter Heft 12. 1954

VI. LIST OF PREVIOUS PUBLICATIONS

21. V.F. Hess and J. Eugster
Cosmic Radiation and its biological Effects,
Fordham Univ. Press NY. 1949
22. J. Eugster
Experientia Vol. VII Fasc. 12 Dec. 1951
Bull. Schw. Ges. f. Anthrop., Mutagener Ef-
fekt d. Kosm. Str. 1952/53, p. 49.
Radiologia Clinica Vol. 21 No. 1. 1952
Vol. 22 No. 2 1952
Physikal. Blätter Heft 6. 1952
Physikal. Verhandlungen Heft 3. 1952
Bulletin Schweiz. Akademie Med. Wissensch.
Vol. 9 Fasc. 2. 1953
Journal of Aviation Medicine. Vol. 24, p. 222,
1953
Rev. Scientif. Instruments Jan. 1954
23. J. Eugster, H. Schaefer, H. Waeffler, L. Jenny,
preface: P. Scherrer
Weltraumstrahlung
Verlag H. Huber, Bern, Stuttgart.

P L A T E I

Fig. 1

Correlation of photographic tracks and dye effects

A heavy primary penetrates a whole package of photographic plates and continues through the dye-gelatine mixture. Here it gives rise to a sharply demarcated red spot.

This is the first definite demonstration of CR detection by means of a dyestuff technique. (TTC = Triphenyl-Tetrazolium-Chloride).

Exposure: Holloman, 68 hours above 90'000 feet.

Plate I

Correlation of photographic tracks and dye effects.

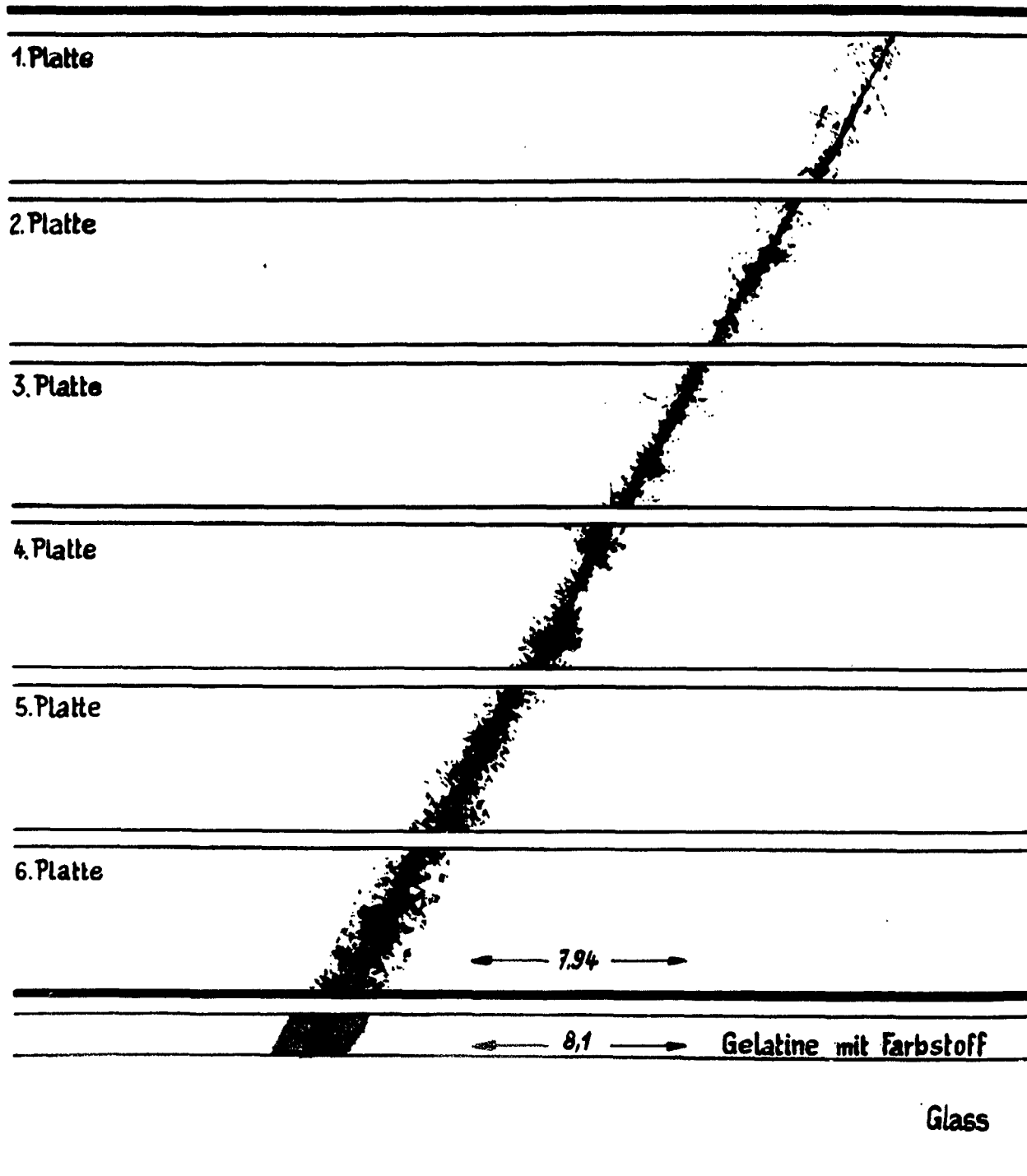

Scale 50:1

Angle 63°

Tracks shortened

Fig. 1

Plate II



Fig. 2

P L A T E I I

Fig. 2

Nuclear fission figure produced by CR in human tissue
(omentum majus)

Method: Specimes injected with fluid Ilford G 5 emulsion.
The fission figure shown was pieced together from 26
single photographs.

Exposure: Jungfrauoch, 2 months.

Scale: see left side of figure.

PLATE III

Fig. 3

"Photo-Cultures"

Experimental set-up with a perforated holder, above and below which the nuclear plates will be attached. The biological test objects (eggs, pupae) are placed in the circular holes.

Scale 1:2.

Fig. 4

Transportation of skin specimens

(Man, mouse). Specimens dehydrated and deep-frozen, stored in evacuated pyrex glass tube.

Of course it would be possible to use bigger specimens from humans, so that they would cover the support completely.

Fig. 5

Heavy primary track in culture of Artemia eggs

Those eggs covered by the track at its left end must be considered maximally hit. This is the path connecting the exit of the track from the plate above to its entry into the plate below.

Exposure: Holloman, 24 and 68 hours above 90'000 feet.

Plate III

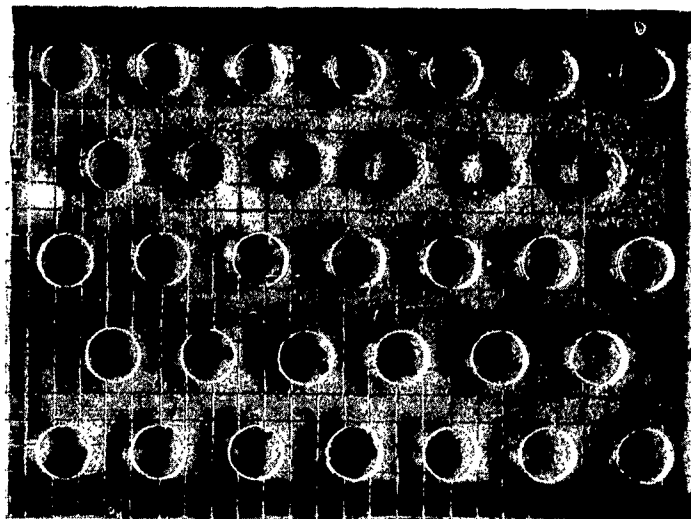

Fig. 3

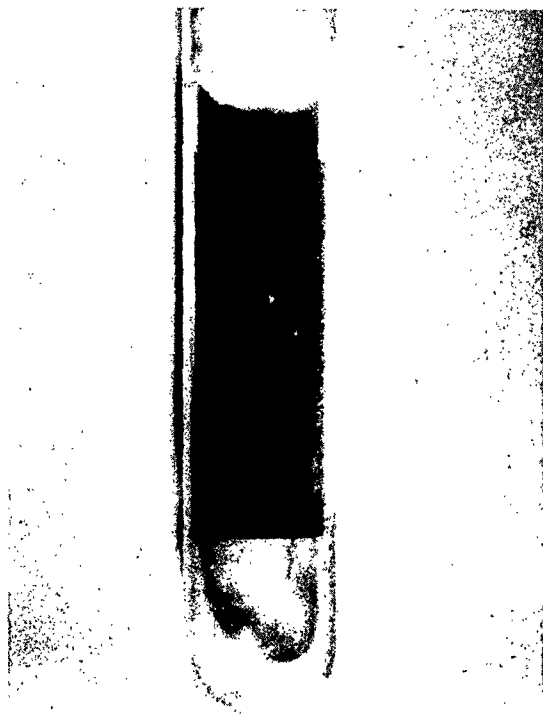

Fig. 4

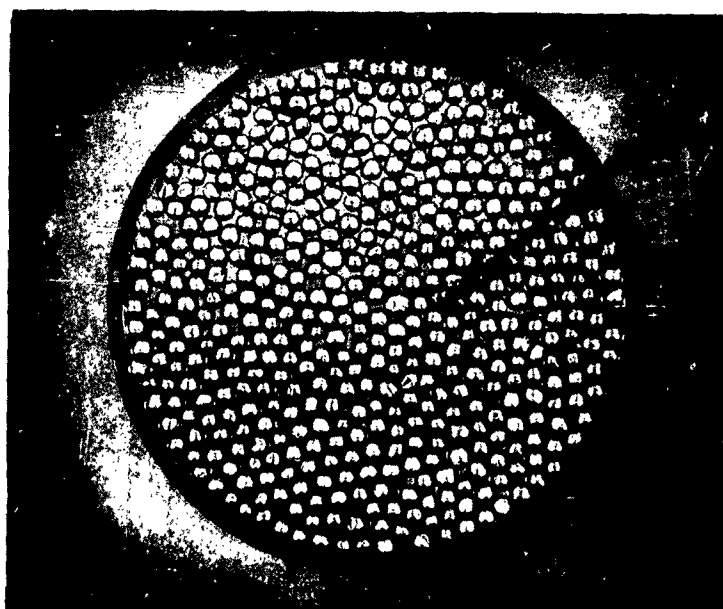

Fig. 5

Plate IV



Fig. 6



Fig. 7

PLATE IV

Fig. 6 (Case E. R., Protocol No. I, XX & XXI)

Skin specimen one week after re-implantation

Superficial keratinization.

Stratum germinativum intact.

Exposure: Payerne, 75'000 feet.

Serum method.

This proves a piece of skin to be re-implantable after transportation. No damage through CR can be demonstrated.

Fig. 7 (Case A. T., male)

Histological picture of skin specimen, 6 weeks after re-implantation. Stratum germinativum wholly intact, no pathological changes.

Exposure: Holloman, 26 hours above 90'000 feet, "dry" technique.

PLATE V

Fig. 8

Piece of human skin 3 weeks after auto-reimplantation. In the centre of the black circle is the hit locus which, immediately after the exposure, was marked out by TTC. After about 2 weeks the dye underwent resorption. At the moment of photographing, no change is apparent at the hit locus.

Scale 1:1.

Fig. 9

Same as Fig. 8 after a latency period of 14 months. A small nodule with a diameter of 1-2 mm has formed, showing a yellow-brown surface (beginning pigmentation). The circle marking out the hit was drawn anew, the colour having faded.

Scale 3:1.

Fig. 10

Control with TTC dye. TTC was injected locally in order to prove that the dye by itself will not produce any skin reaction. Period of observation: one year.

Fig. 11

Same as Fig. 10, more than one year later. No reaction at all has occurred (no granuloma, no pigmentation).

Plate V

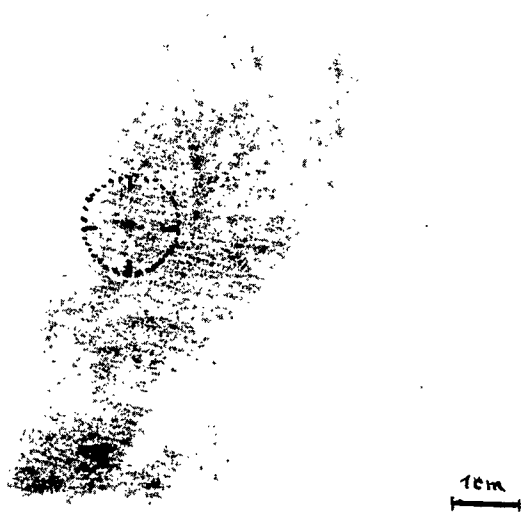

Fig. 8

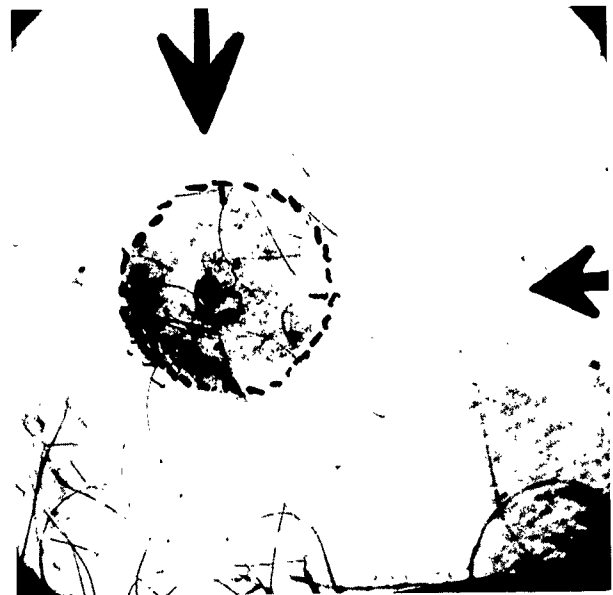

Fig. 9



Fig. 10

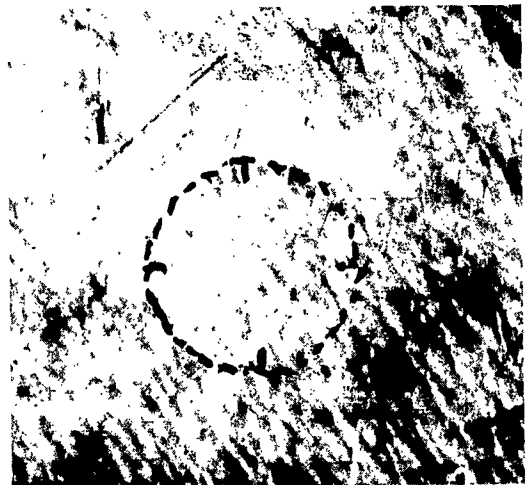
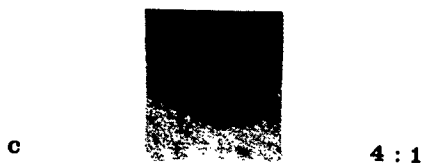
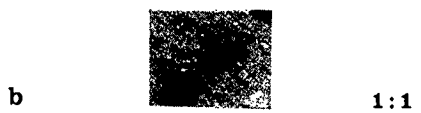
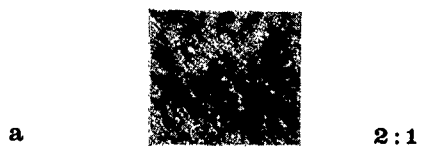

Fig. 11

Plate VI

Fig. 12



P L A T E VI

Fig. 12

Auto-reimplantate of human skin after 2 years of observation (January 10th, 1956; reimplantation done Jan. 10th, 1954). At the locus of the original hit a dark-brown pigmentation has formed. That this is not an ordinary pigmented naevus can be seen from the 3 zones clearly distinguishable:

- 1) Centre with intense black pigmentation.
- 2) Intermediate zone: red-brown halo.
- 3) Outer zone: red, hyperaemic.

A comparison of this phenomenon with Fig. 1 is interesting, where in the gelatine a distinct, heavily stained central zone, surrounded by a halo, can also be seen.

Fig. 12a

About $\frac{1}{2}$ year after reimplantation.

Fig. 12b

Ten months after reimplantation.

Fig. 12c

Two years after reimplantation. Tracks of the circle marking are visible.

Teilung } 1-10000
Logar. Division }
Einheit } 62.5 mm
Unité }

WINZEN RESEARCH INC.

FLIGHT No. 502

Date: 5 - 6 Aug. 1955

Beacon No 4 1752 KC

(Calibration Temp. 65° F.)

Exposure: Beads of BORDEUM BORUS 81g

Series J 1955 / 56 (Rotations)

Ed. Aerni-leuch, Bern. Nr. 528

